

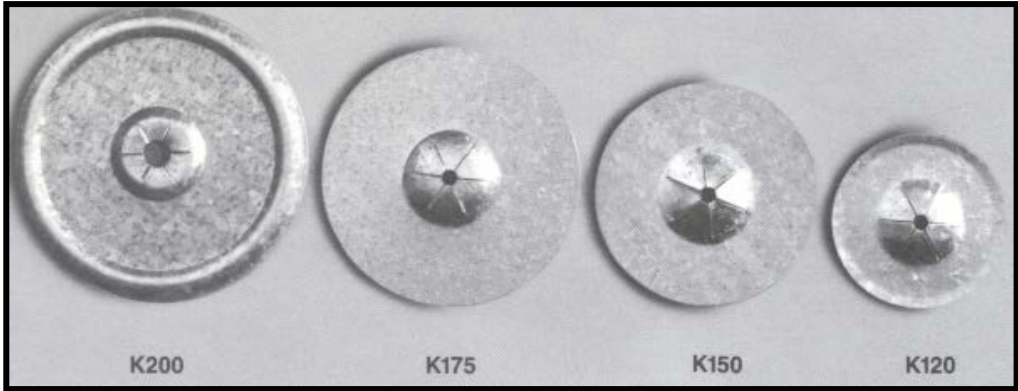

# SELF LOCKING WASHERS - ROUND

**To order or specify give:**  
 Product Code: **WCN**    Diameter:    Type:Specify    Material:Specify  
**Pin on which washer is to be used**



**SUNBELT** Self –Locking Washers are used in conjunction with **SUNBELT** weld pins, insul-anchors and lacing anchors to fasten insulation in place. Simply press the self-locking washer onto the pin up against the insulation until the desired position is reached and then clip off, or bend over, the remaining portion of pin for a permanent attachment.

The choice between round or square self-locking washers is basically a matter of aesthetics or personal preference. The domed, multi-lanced hole design provides for ease of locating washer on pin and positive self-locking. Some styles of washers are manufactured with a beveled edge to prevent the washer from cutting into the insulation facing. **SUNBELT** Self-Locking Washers are available according to the chart above and with standard 10 GA, 12 GA, or 14 GA hole sizes off-the-shelf. Other material/plating combinations and hole sizes are available by special order.

<i>TYPE</i>	<b>K200</b>	<b>K175</b>	<b>K150</b>	<b>K120</b>
<i>SIZE</i>	2"	1-3/4	1-1/2	1-3/16
<i>THICKNESS</i>	.015 nom.	.015 nom.	.015 nom.	.015 nom.
<i>MATERIAL</i>	Mild Steel	Mild Steel	Mild Steel	Mild Steel
<i>PLATING</i>	Galvanized	Galvanized	Galvanized	Galvanized
<i>EDGES/FLAT OR BEVELED</i>	beveled	flat	flat	beveled
<i>OTHER MATERIALS AVAILABLE</i>	Alum., S.S.	Alum., S.S.	Alum., S.S.	---
<i>PACKED PER CARTON</i>	2000	1000	1000, 5000	1000, 5000
<i>SHIPPING WEIGHT PER 1,000</i>	19 lbs.	10-1/2 lbs.	8 lbs.	6 lbs.

[www.sunbeltstudwelding.com](http://www.sunbeltstudwelding.com)

**Sunbelt Stud Welding, Inc**  
**6381 Windfern Road**  
**Houston, Texas 77040-4915**



**1-800-462-9353**  
**713-939-8903**  
**fax 713-939-9013**



## **SELF LOCKING WASHERS (SQUARE)**

**To order or specify give:**

Product Code: **WCN**      Diameter:      Type:Specify      Material:Specify  
**Pin on which washer is to be used**

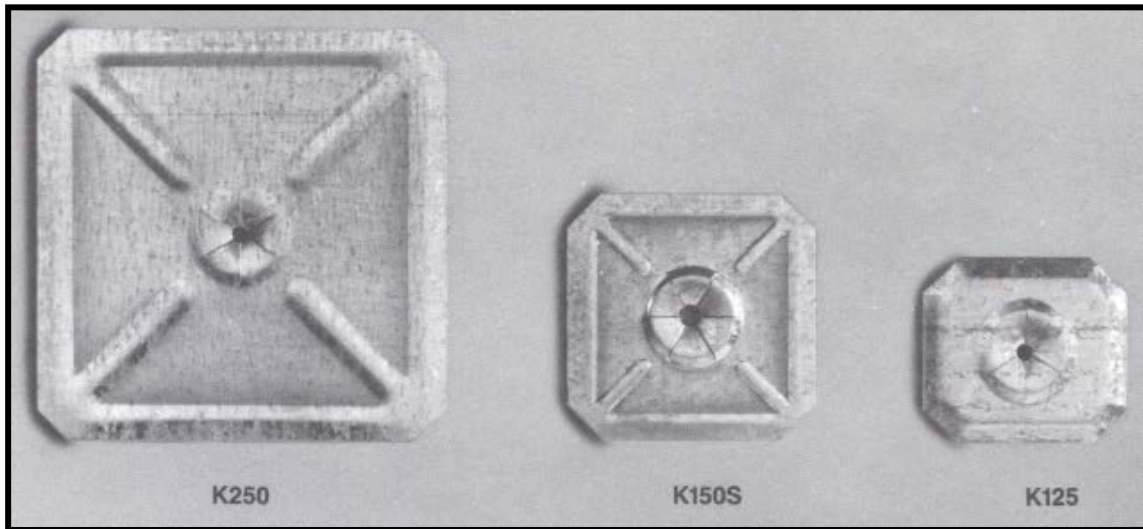

TYPE	K250	K150S	K125
SIZE	2 1/2" X 2 1/2"	1 1/2" X 1 1/2"	1" X 1 1/4"
THICKNESS	.015 nom.	.015 nom.	.015 nom.
MATERIAL	Mild Steel	Mild Steel	Mild Steel
PLATING	Galvanized	Galvanized	Galvanized
EDGES/FLAT OR BEVELED	Beveled	Beveled	Beveled
OTHER MATERIALS AVAILABLE	Alum, SS	Alum, SS	Alum SS
PACKED PER CARTON	1000	3000	1000, 5000
SHIPPING WEIGHT PER 1,000	28 1/2 lbs.	10 lbs.	6 lbs.

**SUNBELT** Self-Locking Washers are used in conjunction with **SUNBELT** weld pins, insul-anchors and lacing anchors to fasten insulation in place. Simply press the self-locking washer onto the pin, against the insulation until the desired position is reached and then clip off, or bend over, the remaining portion of pin for a permanent attachment.

The choice between round or square self-locking washers is basically a matter of aesthetics or personal preference. The domed, multi-lanced hole design provides for ease of locating washer on pin and positive self-locking. Some styles of washers are manufactured with a beveled edge to prevent the washer from cutting into the insulation facing. These washers are available according to the chart above and with standard 10 GA, 12 GA, or 14 GA hole sizes off-the-shelf. Other material/plating combinations and hole sizes are available by special order.

[www.sunbeltstudwelding.com](http://www.sunbeltstudwelding.com)

**Sunbelt Stud Welding, Inc**  
**6381 Windfern Road**  
**Houston, Texas 77040-4915**



**1-800-462-9353**  
**713-939-8903**  
**fax 713-939-9013**



# NAVY STUDS - WASHERS, CAPS & NUTS

## Annular Ring Cap (for annular ring studs)

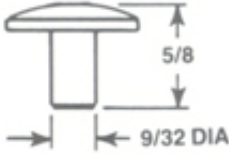

**To order or specify give:**  
Product Code: **WCN AR CAP** Size: Specify



APPLICATION	Designed to permanently lock on to Navy annular ring studs.
MATERIAL	Mild Steel / Zinc Plated, 304 Stainless Steel, 316 Stainless Steel & Aluminum.
SIZE	For 1/8" or 3/16" diameter studs.

## Key Hole Slotted Washer (for 3/16 diameter notched end studs)

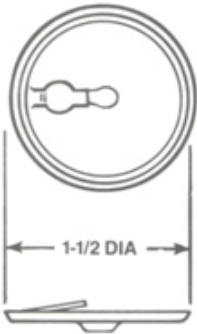

**To order or specify give:**  
Product Code: **WCN NE KHS** Material: Specify

APPLICATION	Designed to lock on to Navy notched end studs.
MATERIAL	Mild Steel - Cadmium Plated Mild Steel - Galvanized

## Flat Washers & Hex Nuts (for all threaded studs)

Note: Most standard hex nuts, flat washers, and lock washers are available in a variety of sizes and materials for threaded mil-spec. Navy studs such as pitch diameter, shoulder, reduced base and collar.

[www.sunbeltstudwelding.com](http://www.sunbeltstudwelding.com)

**Sunbelt Stud Welding, Inc**  
6381 Windfern Road  
Houston, Texas 77040-4915



**1-800-462-9353**  
**713-939-8903**  
**fax 713-939-9013**



# MISCELLANEOUS INSULATION WASHERS

### Insulation Washers: Capped Speed Washer

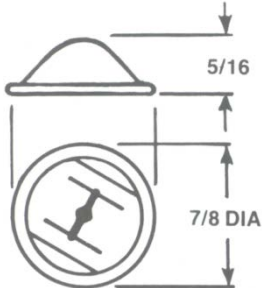

**To order or specify give:**  
 Product Code: **WCN CSW**                      Size: 12 GA                      Color: Specify

<b>APPLICATION</b>	Designed to permanently lock on to 12 GA weld pins or insul-anchors where appearance is a major factor, or where no sharp points or edges are permissible on the surface.
<b>MATERIAL</b>	Decorative Domed Cap - Aluminum Self-Locking Insert - Hardened Steel
<b>COLOR</b>	Plain (bright aluminum) or painted white. Other painted colors are available by special order.

### Insulation Washers: Prong Washer

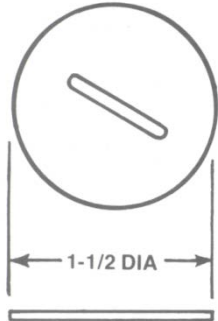

**To order or specify give:**  
 Product Code: **WCN P150**    Material: Specify

<b>APPLICATION</b>	Designed to be used with Sunbelt Stud Welding Prong Insul-Anchors. Slide over prong and bend prong tabs down in opposite directions.
<b>MATERIAL</b>	Mild Steel - Galvanized and Aluminum. Stainless Steel is available by special order.
<b>SLOT SIZE</b>	3/32" x 13/16"

### Insulation Washers: Lacing Washer & Ring

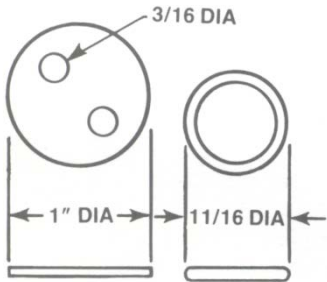

**To order or specify give:**  
 Product Code: **LA L100 or LA RING**    Material: (Washer)

<b>APPLICATION</b>	Designed to be used with lacing wire to wrap insulation around irregular shapes.
<b>MATERIAL</b>	Washer - Aluminum or Stainless Steel Ring - Zinc alloy, bright zinc plated
<b>NO-AB</b>	Washers are available stamped NO AB to indicate non-asbestos material

[www.sunbeltstudwelding.com](http://www.sunbeltstudwelding.com)

**Sunbelt Stud Welding, Inc**  
 6381 Windfern Road  
 Houston, Texas 77040-4915



**1-800-462-9353**  
**713-939-8903**  
**fax 713-939-9013**



# PANEL CAPS & NUTS

## Annular Groove Cap (for annular groove shoulder studs)

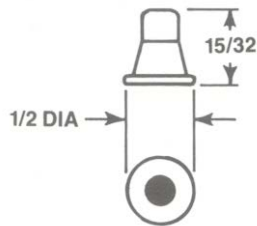

**To order or specify give:**  
Product Code: **WCN AG CAP**

<b>APPLICATION</b>	Designed to permanently lock on to annular groove shoulder studs to hold panel in place against stud shoulder.
<b>MATERIAL</b>	Aluminum
<b>SIZE</b>	For 3/16" diameter annular groove.

## Cap Setting Tool (for installing AG Caps)



**To order or specify give:**  
Name: **Cap Setting Tool**

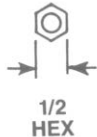

<b>APPLICATION</b>	This tool is recommended for installing the Annular Groove Cap (above).
--------------------	---

## Panel Nut (for 1/4-20 threaded studs)

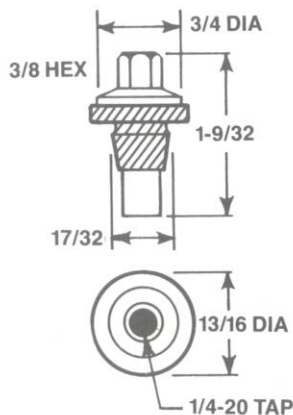

**To order or specify give:**  
Product Code: **WCN PANUT**

<b>APPLICATION</b>	Designed to be threaded down through pre-drilled holes in the panel on to pre-welded studs providing firm, water resistant attachment.
<b>MATERIAL</b>	Aluminum & Neoprene Rubber
<b>SIZE</b>	For 1/4-20 threaded studs

[www.sunbeltstudwelding.com](http://www.sunbeltstudwelding.com)

Sunbelt Stud Welding, Inc  
6381 Windfern Road  
Houston, Texas 77040-4915



1-800-462-9353  
713-939-8903  
fax 713-939-9013



# REFRACTORY ANCHORS - WASHERS & RETAINERS

## Insul-twist Washer

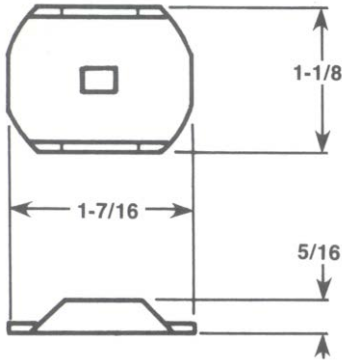

**To order or specify give:**  
 Product Code: **WCN ITW**    Length: Specify    Size: Specify    Material: Specify

**APPLICATION**    Designed for 1/4 turn locking on to SUNBELT INSULTWIST refractory anchors.

**MATERIAL**  
 Stainless Steel: 304  
 Stainless Steel: 310  
 Stainless Steel: 330  
 Inconel: 601

**WASHER**    Sold seperately. Not a component part of stud.

## Insul-twist Cup

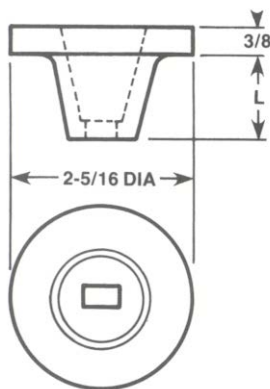

**To order or specify give:**  
 Product Code: **WCN ITC**    Length: **L**

**APPLICATION**    Designed for 1/4 turn locking on to Sunbelt Stud Welding Insultwist refractory anchors.

**MATERIAL**    Ceramic (High Temperature)

**SIZE**  
 L    Short - 1"  
       Long - 2"

[www.sunbeltstudwelding.com](http://www.sunbeltstudwelding.com)

**Sunbelt Stud Welding, Inc**  
 6381 Windfern Road  
 Houston, Texas 77040-4915



**1-800-462-9353**  
**713-939-8903**  
**fax 713-939-9013**





**REFRACTORY - DRIVE PLATE**

**Drive Plate**

To order or specify give:  
Product Code: **WCN DRPLT**

<b>APPLICATION</b>	Designed to lock on to Sunbelt Stud Welding 5/16" diameter Knurled Studs.
<b>MATERIAL</b>	Mild Steel

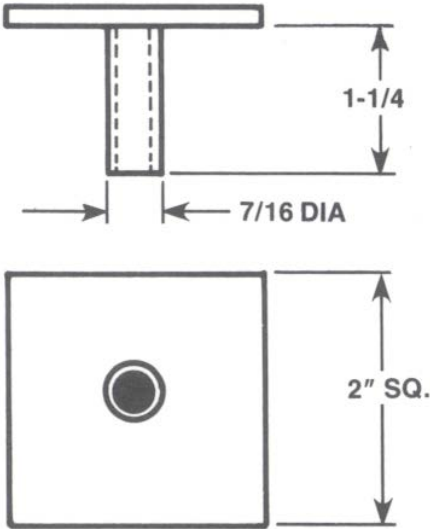

[www.sunbeltstudwelding.com](http://www.sunbeltstudwelding.com)

Sunbelt Stud Welding, Inc  
6381 Windfern Road  
Houston, Texas 77040-4915



1-800-462-9353  
713-939-8903  
fax 713-939-9013



**STANDARD HEX NUTS**

**HEX NUTS (American Standard)**

**WCN HEX**

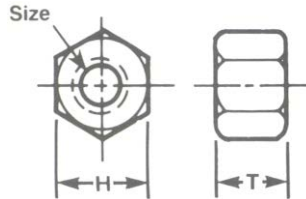

SIZE	H	T
#6	5/16	7/64
#8	11/32	1/8
#10	3/8	1/8
1/4	7/16	7/32
5/16	1/2	17/64

SIZE	H	T
3/8	9/16	21/64
7/16	11/16	3/8
1/2	3/4	7/16
5/8	15/16	35/64
3/4	1-1/8	41/64

**HEX JAM NUTS (American Standard)**

**WCN HEXJAM**

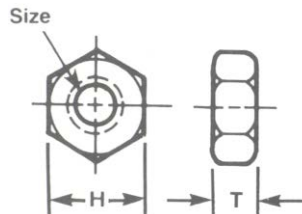

SIZE	H	T
1/4	7/16	5/32
5/16	1/2	3/16
3/8	9/16	7/32
7/16	11/16	1/4

SIZE	H	T
1/2	3/4	5/16
5/8	15/16	3/8
3/4	1-1/8	27/64

[www.sunbeltstudwelding.com](http://www.sunbeltstudwelding.com)

Sunbelt Stud Welding, Inc  
 6381 Windfern Road  
 Houston, Texas 77040-4915



1-800-462-9353  
 713-939-8903  
 fax 713-939-9013





# STANDARD FLAT WASHERS

**FLAT WASHERS (American Standard – Type A, Series W)**

**WCN FLAT**

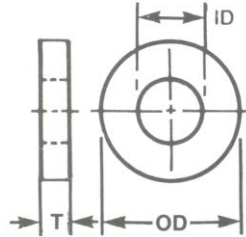

SIZE	ID	OD	T
#6	5/32	3/8	3/64
#8	3/16	7/16	3/64
#10	7/32	1/2	3/64
1/4	5/16	47/64	1/16
5/16	3/8	7/8	5/64

SIZE	ID	OD	T
3/8	7/16	1"	5/64
7/16	1/2	1-1/4	5/64
1/2	9/16	1-3/8	7/64
5/8	11/16	1-3/4	9/64
3/4	13/16	2"	5/32

**LARGE OD FLAT WASHERS (American Standard – Type B, Series W) WCN LODFLT**

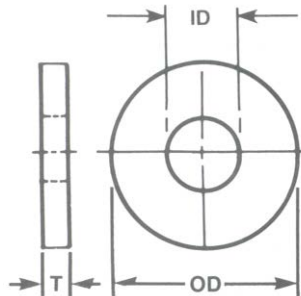

SIZE	ID	OD	T
1/4	9/32	1"	1/16
5/16	11/32	1-1/8	1/16
3/8	13/32	1-1/4	3/32
7/16	15/32	1-15/32	3/32

SIZE	ID	OD	T
1/2	17/32	1-3/4	3/32
5/8	21/32	2-1/4	5/32
3/4	13/16	2-1/2	5/32

[www.sunbeltstudwelding.com](http://www.sunbeltstudwelding.com)

Sunbelt Stud Welding, Inc  
6381 Windfern Road  
Houston, Texas 77040-4915



1-800-462-9353  
713-939-8903  
fax 713-939-9013



# STANDARD LOCK WASHERS

## SPLIT LOCK WASHER

WCN SPLIT

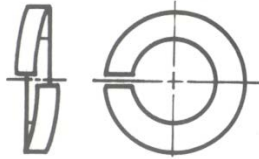

SIZES									
#6	#8	#10	1/4	5/16	3/8	7/16	1/2	5/8	3/4

## INTERNAL TOOTH LOCK WASHER

WCN INT

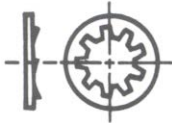

SIZES					
#6	#8	#10	1/4	5/16	3/8

## EXTERNAL TOOTH LOCK WASHER

WCN EXT

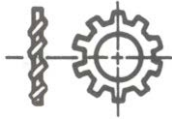

SIZES					
#6	#8	#10	1/4	5/16	3/8

## INTERNAL/EXTERNAL TOOTH LOCK WASHER

WCN INTEXT

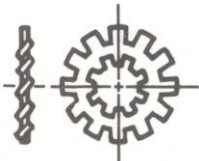

SIZES					
#6	#8	#10	1/4	5/16	3/8

**TYPE & SIZE:** Types and sizes shown are standard. Many other types and sizes are available by special order. All dimensions shown are  $\pm 1/64"$ .

**MATERIAL:** HEX NUTS and FLAT WASHERS are available in mild steel (unplated or zinc plated), stainless steel, aluminum and brass. LOCK WASHERS are available in mild steel (unplated or zinc plated) and stainless steel. Other materials are available by special order.

**TO ORDER OR SPECIFY:** Give Product code (WCN) + size + material.

[www.sunbeltstudwelding.com](http://www.sunbeltstudwelding.com)

**Sunbelt Stud Welding, Inc**  
 6381 Windfern Road  
 Houston, Texas 77040-4915



3-10

1-800-462-9353  
 713-939-8903  
 fax 713-939-9013