

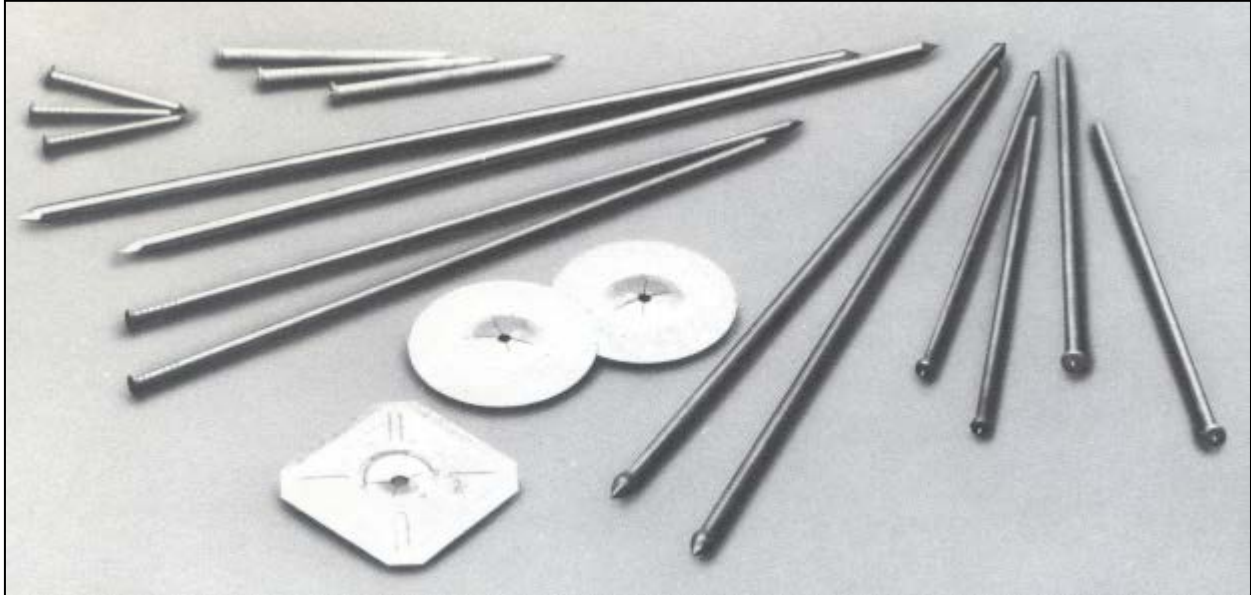

WELD PINS



SUNBELT Weld Pins simplify the permanent attachment of insulation to just about any kind of construction metal surface. They can be applied quickly and easily using standard CD or ARC stud welding equipment.

SUNBELT Weld Pins are available in several different styles to cover a wide variety of application requirements. Some of the factors to consider concerning the style needed for your application would be the base metal type size and surface condition, and also the welding equipment to be used.

SUNBELT Weld Pins are used with **SUNBELT** Self-Locking Washers to complete the insulation fastening operation.

Weld Pins are normally available in the following:

- **MATERIALS:** Mild Steel, Stainless and Aluminum
- **SIZES:** (Diameters) 14 GA, 12 GA, 10 GA
- **LENGTHS:** in 1/4" increments up to 1-1/2" long and 1/2" increments beyond 1-1/2" long.
- Other materials, sizes, and lengths are available on a special order basis.

For more information concerning the application of weld pins, see the reverse side of this page. For more information concerning self-locking washers, refer to the Washers, Caps and Nuts section of this catalog.

www.sunbeltstudwelding.com

Sunbelt Stud Welding, Inc
6381 Windfern Road
Houston, Texas 77040-4915





WELD PIN APPLICATION



1. WELD PINS IN PLACE.

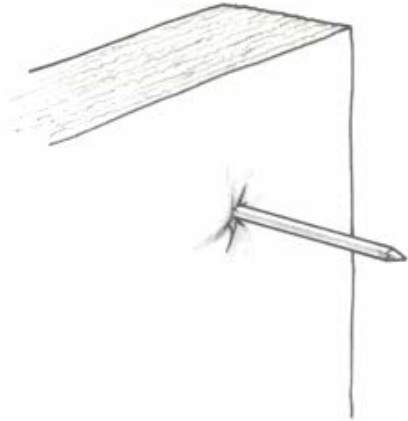

2. HANG INSULATION ON PINS.

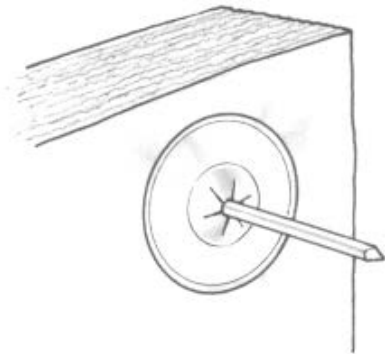

3. PRESS WASHERS ON PINS TO SECURE INSULATION.

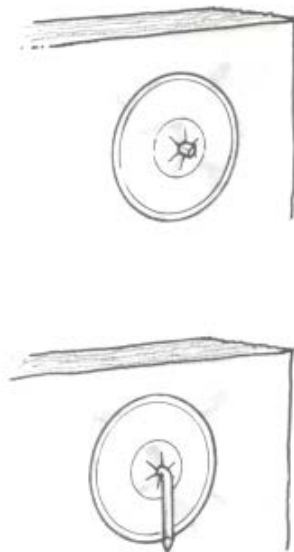

4. EITHER CLIP PINS OFF AT WASHER OR BEND PINS OVER WASHER.

www.sunbeltstudwelding.com

Sunbelt Stud Welding, Inc
6381 Windfern Road
Houston, Texas 77040-4915



1-800-462-9353
713-939-8903
fax 713-939-9013



CD WELD PINS

To order or specify give:
 Product Code: **WP CD** Diameter: Specify Length: **L** Material: Specify

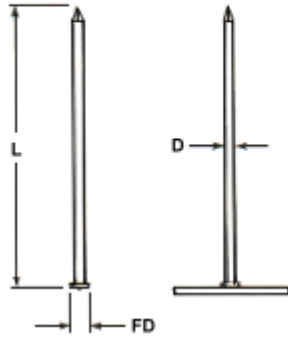

SIZE	PIN		
	D	STEEL FD	ALUM. FD
14GA	.080	.160	---
12 GA	.105	.180	.230
10 GA	.135	.195	.250
9 GA	.148	.230	---

MATERIAL	LOW CARBON STEEL C - 0.23% max. P - 0.04% max. Mn - 0.90% max. S - 0.05% max.	STAINLESS STEEL AISI grade - 302/304/305 std. Other grades available upon request.
MECHANICAL PROPERTIES	Tensile60,000 psi (min.) Yield50,000 psi (min.) Elongation.....20% (in 2 inches)	Values for various grades available upon request.
PLATING	Copper coating is standard on pins. Copper and other platings available upon customer request	Does not apply to Stainless
ANNEALING	Pins are annealed where required	Does not apply

APPLICATION This is the standard weld pin used for most applications.

WASHERS Self-Locking washers are available in a variety of sizes, shapes and materials.

MATERIAL	ALUMINUM Alloy - 1100-H14 standard. Other alloys available upon request
MECHANICAL PROPERTIES	Values for various alloys available upon request.

www.sunbeltstudwelding.com

Sunbelt Stud Welding, Inc
 6381 Windfern Road
 Houston, Texas 77040-4915



1-800-462-9353
713-939-8903
 fax **713-939-9013**



WELD PINS: DOUBLE POINTED ARC

To order or specify give:
 Product Code: **WP DP** Diameter: Specify Length: Specify **L** Material: Specify

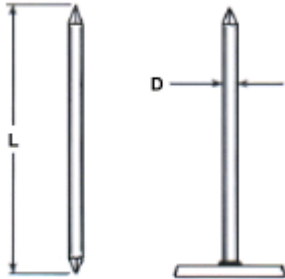

PIN			
SIZE	D*	L	FERRULE CODE
10 GA	.135	AS REQUIRED	F135

*Other diameters available upon request

MATERIAL	LOW CARBON STEEL	STAINLESS STEEL	
	C - 0.23% max. Mn - 0.90% max.	P - 0.04% max. S - 0.05% max.	AISI grade - 302/304/305 std. Other grades available upon request.
MECHANICAL PROPERTIES	Tensile	60,000 psi (min.)	Values for various grades available upon request.
	Yield	50,000 psi (min.)	
	Elongation	20% (in 2 inches)	
PLATING	Copper coating is standard	Does not apply to Stainless	
ANNEALING	Can be annealed if required	Can be annealed if required	

WASHERS Self-Locking washers are available in a variety of sizes, shapes and materials.

APPLICATION This is the standard weld pin used for insulation fastening when only ARC stud welding equipment is available.

www.sunbeltstudwelding.com

Sunbelt Stud Welding, Inc
6381 Windfern Road
Houston, Texas 77040-4915



1-800-462-9353
713-939-8903
fax 713-939-9013



WELD PINS: "SURE-FIRE"

To order or specify give:
 Product Code: **WP SF** Diameter: Specify Length: Specify **L** Material: Specify

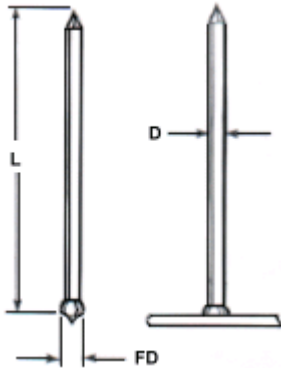

PIN			
SIZE	D	L	FD
12 GA	.105	AS REQUIRED	.175
10 GA	.135	AS REQUIRED	.195

MATERIAL	LOW CARBON STEEL C - 0.23% max. P - 0.04% max. Mn - 0.90% max. S - 0.05% max.	STAINLESS STEEL AISI grade - 302/304/305 std. Other grades available upon request.
MECHANICAL PROPERTIES	Tensile 60,000 psi (min.) Yield 50,000 psi (min.) Elongation 20% (in 2 inches)	Values for various grades available upon request.
PLATING	Copper coating is standard	Does not apply to Stainless
ANNEALING	Can be annealed if required	Can be annealed if required

APPLICATION Ideally suited for welding to surfaces covered with mill scale, rust or paint.

WASHERS Self-Locking washers are available in a variety of sizes, shapes and materials.

www.sunbeltstudwelding.com

Sunbelt Stud Welding, Inc
6381 Windfern Road
Houston, Texas 77040-4915



1-800-462-9353
713-939-8903
fax 713-939-9013



WELD PINS: CONICAL TIP

To order or specify give:
 Product Code: **WP CT** Diameter: Specify Length: Specify **L** Material: Specify

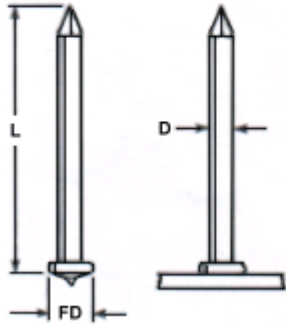

PIN			
SIZE	D	L	FD
12 GA	.105	AS REQUIRED	.220
10 GA	.135	AS REQUIRED	.250

MATERIAL	ALUMINIUM: Alloy - 110-H14 std. Other alloys available upon request
MECHANICAL PROPERTIES	Values for various alloys available upon request.

APPLICATION	Ideally suited for welding with production Stud Welding systems.
--------------------	--

WASHERS	Self-Locking washers are available in a variety of sizes, shapes and materials.
----------------	---

www.sunbeltstudwelding.com

Sunbelt Stud Welding, Inc
 6381 Windfern Road
 Houston, Texas 77040-4915



1-800-462-9353
713-939-8903
 fax 713-939-9013