

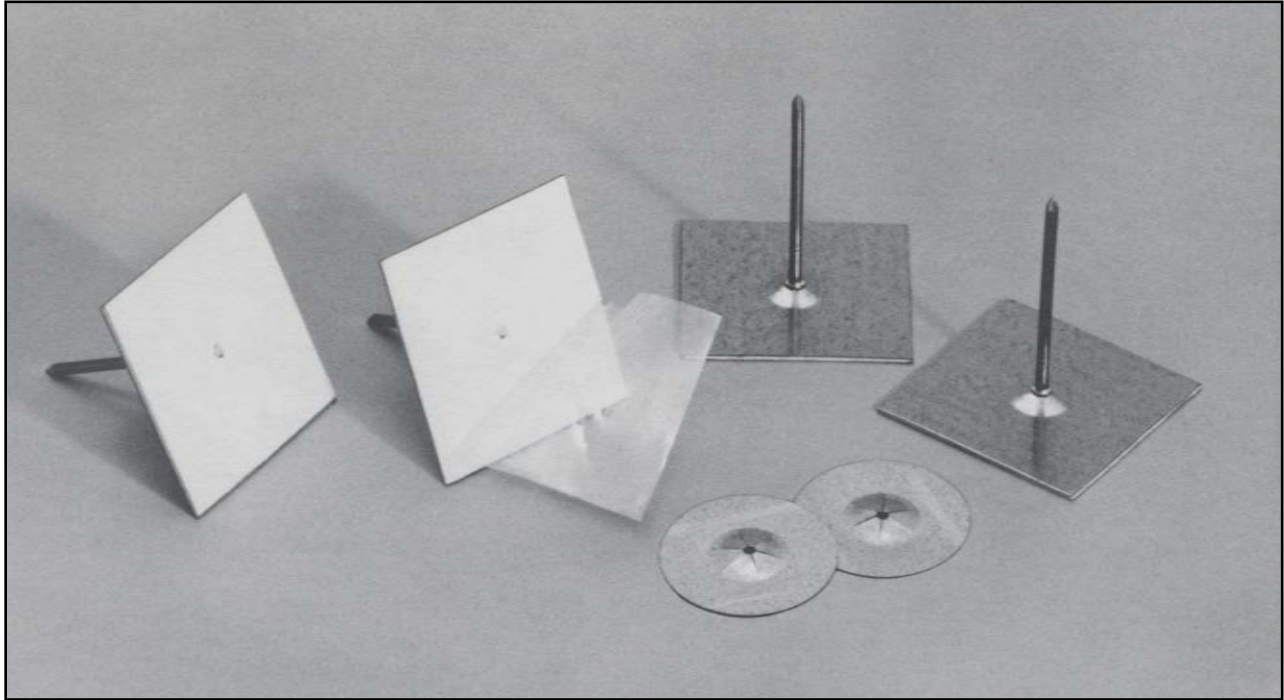

SELF-STICK INSUL-ANCHORS



INSTANT ANCHOR PLACEMENT

SUNBELT Self-Stick Insul-Anchors simplify the permanent installation of insulation to non-porous construction surfaces and non-weldable materials. They can be applied quickly and easily, simply peel off the release backing, press in place, and then hang the insulation. There are no messy adhesives, or time-delay for adhesive curing.

SUNBELT Self-Stick Insul Anchors are available with a 2" x 2" solid plate and 12 Ga. Spindle of varying lengths to meet your requirements. The spindles on short anchors are softened for ease of clipping or bending.

To complete the insulation fastening operation, **SUNBELT** Self-Stick Insul-Anchors are used in conjunction with **SUNBELT** Self-Locking Washers.

For more information concerning the application of **SUNBELT** Self-Stick Insul-Anchors, see the reverse side of this page (4-2) and also the page titled Guidelines for Self-Stick Insul-Anchors (4-3). For more information concerning self-locking washers, refer to the Washers, Caps and Nuts section of this catalog.

www.sunbeltstudwelding.com

Sunbelt Stud Welding, Inc
6381 Windfern Road
Houston, Texas 77040-4915



1-800-462-9353
713-939-8903
fax 713-939-9013



APPLICATION OF SELF-STICK INSUL-ANCHORS



1. WIPE SURFACE CLEAN

Anchor must be applied to a clean, dry and non-porous surface.

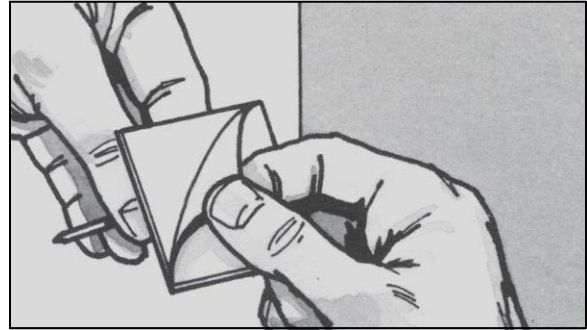

2. PEEL OFF RELEASE BACKING.

Double faced foam tape is 1/32 inch thick, with a 1-year active shelf life.

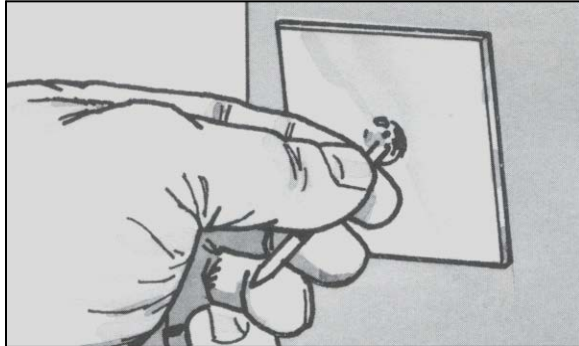

3. STICK ANCHOR IN PLACE.

Select location before contact with surface.
Press firmly.

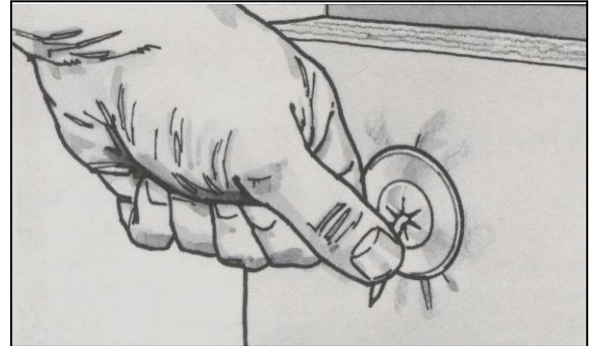

4. HANG INSULATION AND SECURE WITH WASHER.

Recommended loading 3 lbs. Per anchor.
(.75 lbs/sq. inch maximum)

www.sunbeltstudwelding.com

Sunbelt Stud Welding, Inc
6381 Windfern Road
Houston, Texas 77040-4915





GUIDELINES FOR SELF-STICK INSUL-ANCHORS

1. MUST BE APPLIED TO A CLEAN, NON-POROUS SURFACE, THAT IS FREE OF ALL OIL, FILM, DUST, RUST, ETC.
2. NOT RECOMMENDED ON PAINTED SURFACES OR CEILINGS OF METAL BUILDINGS.
3. BEST RESULTS ARE OBTAINED WHEN AMBIENT TEMPERATURE IS ABOVE 40° F. AT TIME OF APPLICATION.
4. TEMPERATURE RANGE FOR THE FOAM TAPE IS FROM -20° TO + 180° F.
5. LOADING SHOULD NOT EXCEED 3 LBS. PER ANCHOR. (.75LB./SQ. INCH)
6. MUST BE APPLIED WITH FIRM (20 POUNDS) PRESSURE ALL AROUND BASE. DO NOT TWIST DURING APPLICATION. DO NOT REMOVE RELEASE (BACKING) PAPER UNTIL READY TO USE.
7. INSULATION MAY BE APPLIED 1/2 HOUR AFTER BOND IS MADE.
8. NOT RECOMMENDED FOR USE ON SINGLE SKIN ROOFDECKS.

IMPORTANT NOTICE TO PURCHASER

- All statements, technical information and recommendations contained herein are based on tests we believe to be reliable, but the accuracy or completeness thereof is not guaranteed, and the following is made in lieu of all warranties, expressed or implied.
- Seller's and manufacturer's only obligation shall be to replace such quantity of the product proved to be defective. Neither seller nor manufacturer shall be liable for any injury, loss or damage direct or consequential, arising out of the use of or the inability to use the product.
- Before using, user shall determine the suitability of the product for his intended use, and user assumes all risk and liability whatsoever in connection therewith.
- No statement or recommendation not contained herein shall have any force or effect unless in an agreement signed by officers of seller and manufacturer.

www.sunbeltstudwelding.com

***Sunbelt Stud Welding, Inc
6381 Windfern Road
Houston, Texas 77040-4915***



***1-800-462-9353
713-939-8903
fax 713-939-9013***



SELF - STICK

To order or specify give:
 Product Code: **IA SS** Length: **L** Size: **12 GA** Material: (if other than standard)

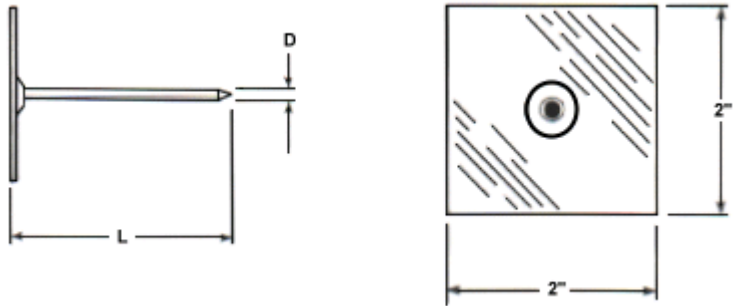

SIZE	D	12 GA (.105") is standard. Other sizes available by special order only.
LENGTH	L	1", 1-5/8", 2", 2-1/2", 3-1/2", 4-1/2", 5-1/2", 6-1/2", 8" and 9" are standard. Other lengths are available by special order.

MATERIAL	PLATE	PIN
	LOW CARBON STEEL	LOW CARBON STEEL
PLATING	Galvanized is standard	Galvanized coating is standard

OTHER MATERIALS Also available by special order in all Stainless Steel or all Aluminum.

NOTE: Aluminum pins are provided on shorter length Insul-Anchors for ease of bending

WASHERS Self-locking washers are available in a variety of sizes, shapes and materials.

www.sunbeltstudwelding.com

Sunbelt Stud Welding, Inc
 6381 Windfern Road
 Houston, Texas 77040-4915



1-800-462-9353
713-939-8903
fax 713-939-9013



SPINDLE, PRONG & NYLON INSUL-ANCHORS

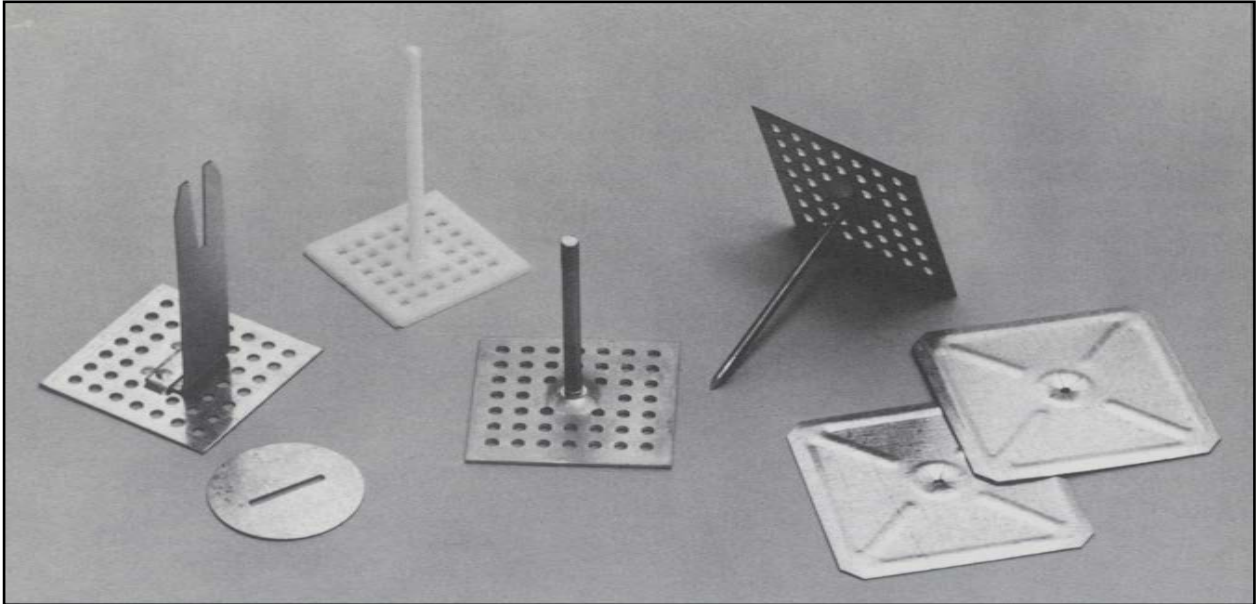

SUNBELT Spindle, Prong and Nylon Insul-Anchors simplify the permanent installation of insulation to porous construction surfaces and non-weldable materials. They can be applied quickly and easily using only a putty knife or caulking gun and **SUNBELT** General Purpose Adhesive.

SUNBELT General Purpose Adhesive is available in quart or gallon cans. The coverage is approximately 800 to 1,000 standard anchors with 2" x 2" plates per gallon. For more information see the [Adhesives](#) section of this catalog.

To complete the insulation fastening operation, **SUNBELT** Spindle and Nylon Insul-Anchors are used in conjunction with **SUNBELT** Self-Locking washers (see [Washers, Caps and Nuts](#) section). The spindles on short anchors are softened for ease of clipping or bending. The **SUNBELT** Prong Insul-anchors are used in conjunction with the **SUNBELT** Prong Washer.

SUNBELT Spindle Insul-Anchors are also available with a curved plate for attaching to corrugated panels. See the reverse side of this page for more information regarding the application of Insul-Anchors.

www.sunbeltstudwelding.com

Sunbelt Stud Welding, Inc
6381 Windfern Road
Houston, Texas 77040-4915



4-5

1-800-462-9353
713-939-8903
fax 713-939-9013



APPLICATION OF SPINDLE, PRONG & NYLON INSUL- ANCHORS



1. WIPE SURFACE CLEAN.

Anchor must be applied to a clean, dry, non-painted surface.

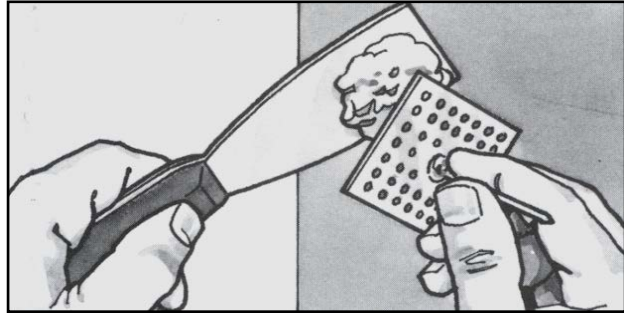

2. APPLY ADHESIVE TO ANCHOR

Spread a daub of General Purpose Adhesive IHA-170 onto the perforated base with putty knife.

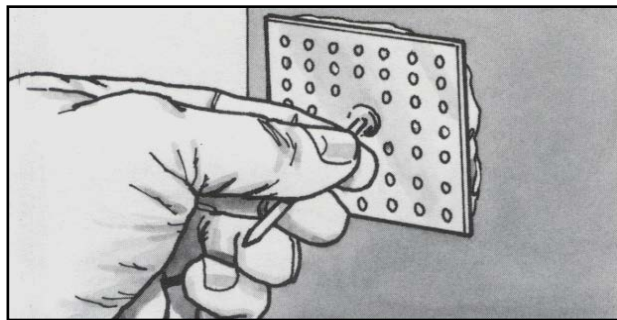

3. STICK ANCHOR IN PLACE

Press anchor into position with twisting motion to spread adhesive evenly. (Adhesive should protrude through perforations & beyond base edges.)

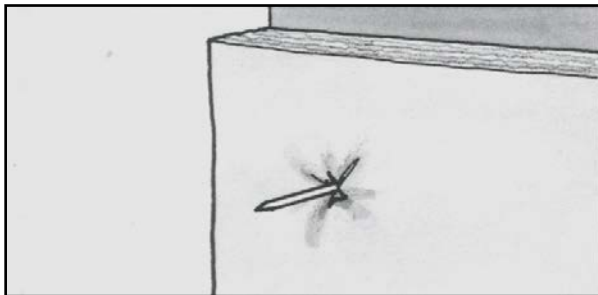

5. HANG INSULATION.

(Allow adhesive to dry thoroughly before hanging insulation: 24-48 hours.)

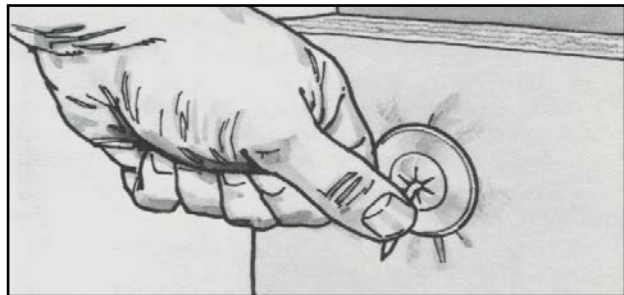

6. SECURE WITH WASHER.

Secure insulation in place with a self-locking washer. (Bend over or clip off the spindle.)

www.sunbeltstudwelding.com

Sunbelt Stud Welding, Inc
6381 Windfern Road
Houston, Texas 77040-4915





SPINDLE

To order or specify give:
 Product Code: **IA SP** Length: **L** Size: **12 GA** Material: (if other than standard)

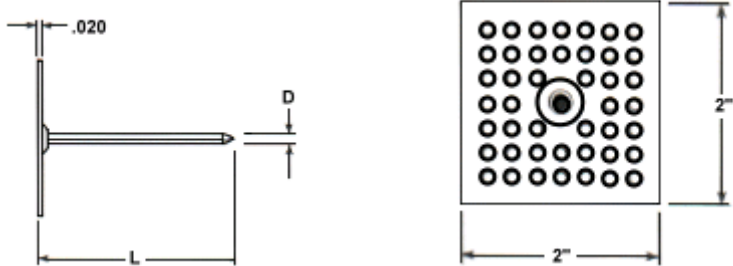

SIZE	D	12GA (.105") is standard. Other sizes available by special order only.
LENGTH	L	1", 1 5/8", 2", 2 1/2", 3 1/2", 4 1/2", 5 1/2", 6 1/2", 8" and 9" are standard. Other lengths are available by special order.

MATERIAL	PLATE	PIN
	LOW CARBON STEEL	LOW CARBON STEEL
PLATING	Galvanized is standard	Galvanized is standard

OTHER MATERIALS Also available by special order in all Stainless Steel or all Aluminum.

NOTE: Aluminum pins are provided on shorter length Insul-Anchors for ease of bending.

WASHERS Self-locking washers are available in a variety of sizes, shapes and materials.

www.sunbeltstudwelding.com

Sunbelt Stud Welding, Inc
 6381 Windfern Road
 Houston, Texas 77040-4915



1-800-462-9353
713-939-8903
 fax **713-939-9013**



ANNULAR RING ANCHOR-BOLT

To order or specify give:
 Product Code: **IA AB-AR** Size: **D** Length: **L** Material: (If other than standard)

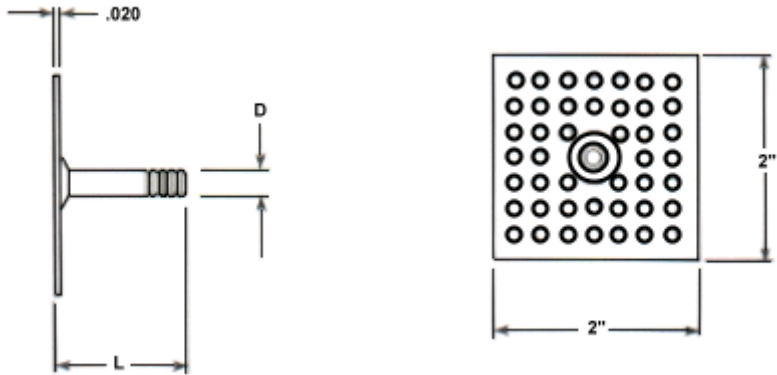

SIZE	D	3/16 Nominal. Actual Ring Diameter is .175"
LENGTH	L	7/8, 1-7/8, 2-7/8, and 3-7/8 are standard. Other lengths are available by special order.

	PLATE	BOLT
MATERIAL	LOW CARBON STEEL	LOW CARBON STEEL
PLATING	Galvanized is standard	Copper plating is standard

OTHER MATERIALS Available by special order only

RETAINING CAP The cap for use with this anchor bolt is the WCN AR CAP part no. 052-297

www.sunbeltstudwelding.com

Sunbelt Stud Welding, Inc
 6381 Windfern Road
 Houston, Texas 77040-4915



1-800-462-9353
 713-939-8903
 fax 713-939-9013



**NOTCHED END
ANCHOR-BOLT**

To order or specify give:
 Product Code: **IA AB-NE** Length: Specify **L** Material: (other than standard)

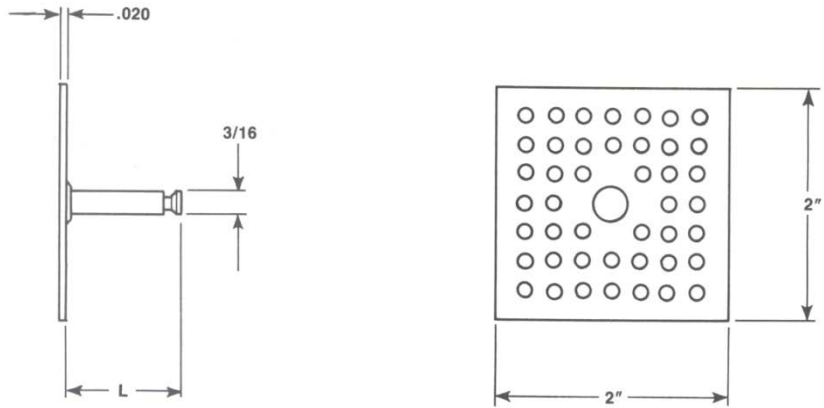

LENGTH	L 7/8, 1-3/8, 1-7/8, 2-7/8, 3-7/8 are standard. Other lengths are available by special order.
---------------	--

	<i>PLATE</i>	<i>PRONG</i>
<i>MATERIAL</i>	LOW CARBON STEEL	LOW CARBON STEEL
<i>PLATING</i>	Galvanized is standard.	Copper plating is standard.

OTHER MATERIALS	Available by special order only
------------------------	---------------------------------

WASHERS	The washer for use with this anchor-bolt is the WCN NE KHS key hole slotted washer part no. 033-1000-45.
----------------	--

www.sunbeltstudwelding.com

Sunbelt Stud Welding, Inc
 6381 Windfern Road
 Houston, Texas 77040-4915



1-800-462-9353
713-939-8903
fax 713-939-9013



THREADED ANCHOR-BOLT

To order or specify give:
 Product Code: **IA AB-THD** Bolt Size: **D** Length: Specify **L** Plate Size: Specify **S** Material: Specify

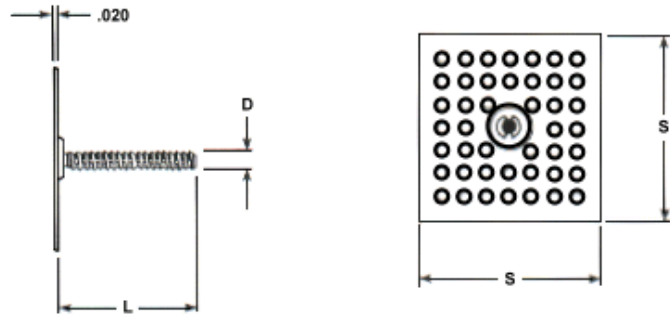

BOLT	D	#10-24 is standard. Other sizes available by special order only.
LENGTH	L	1/4 to 3" long in 1/4" increments is standard
PLATE SIZE	S	1" Square, 1-1/2 Square, 2" Square, and 2-3/4 Square are standard

	PLATE	BOLT
MATERIAL	LOW CARBON STEEL	LOW CARBON STEEL
PLATING	Zinc with yellow chromate	Zinc with yellow chromate

OTHER MATERIALS	Available by special order only
------------------------	---------------------------------

HARDWARE	Hex nuts, flat washers and lock washers are available in a variety of materials.
-----------------	--

www.sunbeltstudwelding.com

Sunbelt Stud Welding, Inc
 6381 Windfern Road
 Houston, Texas 77040-4915



1-800-462-9353
713-939-8903
 fax **713-939-9013**



NYLON

To order or specify give:

Product Code: **IA NY**

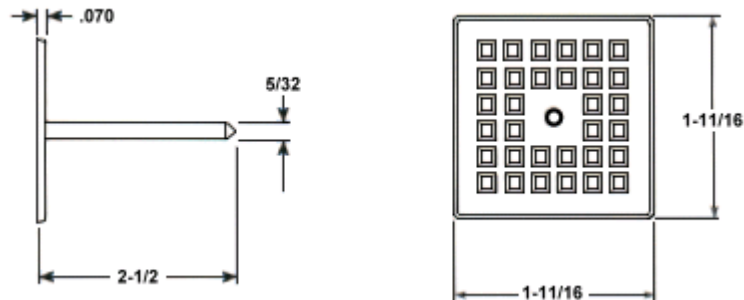

FEATURES

- Can be used for insulation up to 2" thick
- Has a base area 14% larger than similar nylon anchors with a round base
- Has 21% more perforated area for glue extrusion than similar nylon anchors
- These perforations have a beveled lock-tight design (See illustration below)
- Uses 30% less adhesive than metal insul-anchors with a 2" x 2" square base
- Will not conduct heat or cold
- Lighter in weight than metal anchors for ease of handling

MATERIAL

This is a one-piece insulation anchor of molded nylon

WASHERS

The self locking washer for use with this insulation anchor is the WCN K120 BY 5/32-NY part no. 031-0804-13. These washers are packed with anchors.

www.sunbeltstudwelding.com

Sunbelt Stud Welding, Inc
6381 Windfern Road
Houston, Texas 77040-4915



4-11

1-800-462-9353
713-939-8903
fax 713-939-9013



PRONG

To order or specify give:
 Product Code: **IA PG** Length: Specify **L** Material: (if other than standard)

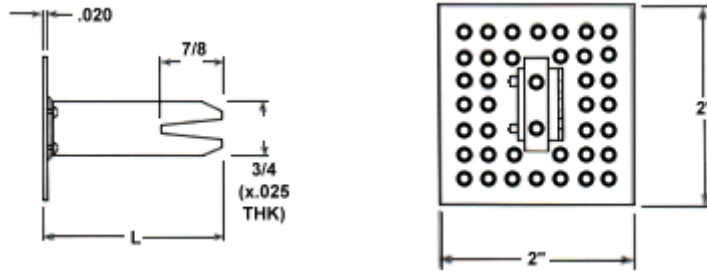

LENGTH	L 1-7/8, 2-3/8, 2-7/8, 3-7/8, 4-7/8 and 6-7/8 are standard. Other lengths are available by special order.
---------------	--

	<i>PLATE</i>	<i>PRONG</i>
MATERIAL	LOW CARBON STEEL	LOW CARBON STEEL
PLATING	Galvanized is standard	Galvanized is standard

OTHER MATERIALS	Available by special order only
------------------------	---------------------------------

WASHERS	The washer for use with this insul-anchor is the WCN P150 FY slotted part no. 041-568.
----------------	--

www.sunbeltstudwelding.com

Sunbelt Stud Welding, Inc
 6381 Windfern Road
 Houston, Texas 77040-4915



1-800-462-9353
713-939-8903
fax 713-939-9013